

Standard 120" Sanitary Manhole Reducers

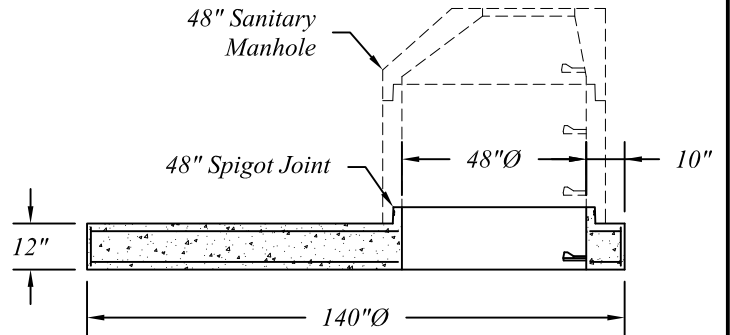

Standard 120" Sanitary Manhole Risers

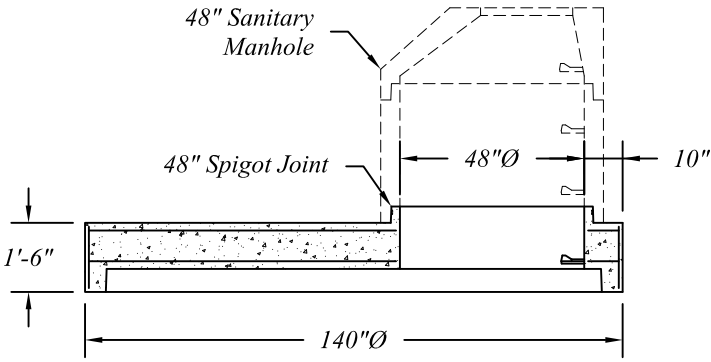
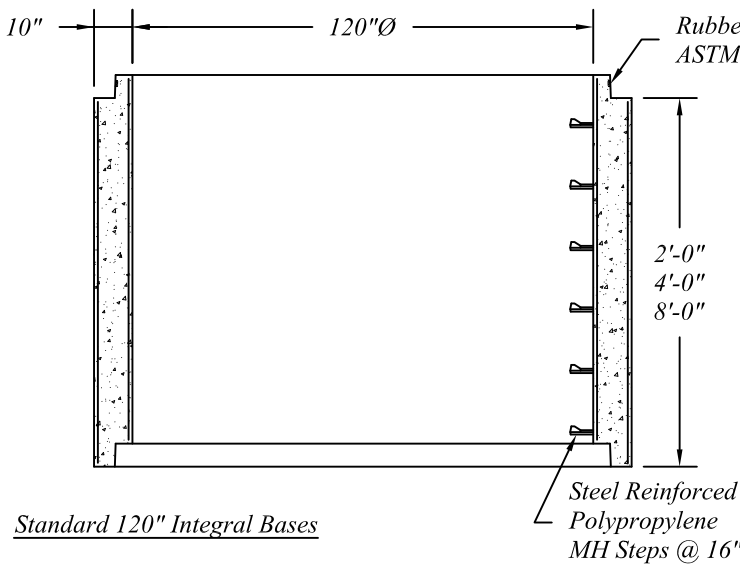

120" Sanitary Manhole Flat Covers  
For Fill Less Than 3.5' Over Pipe

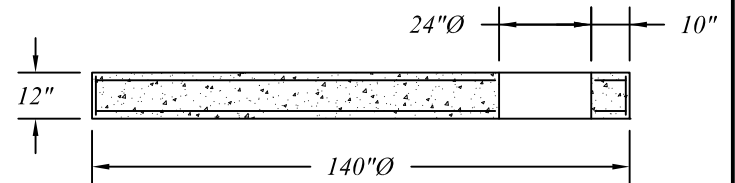
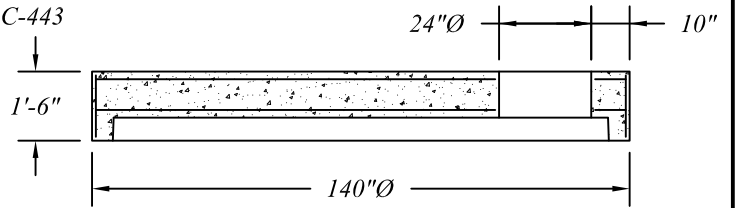

Standard 120" Integral Bases

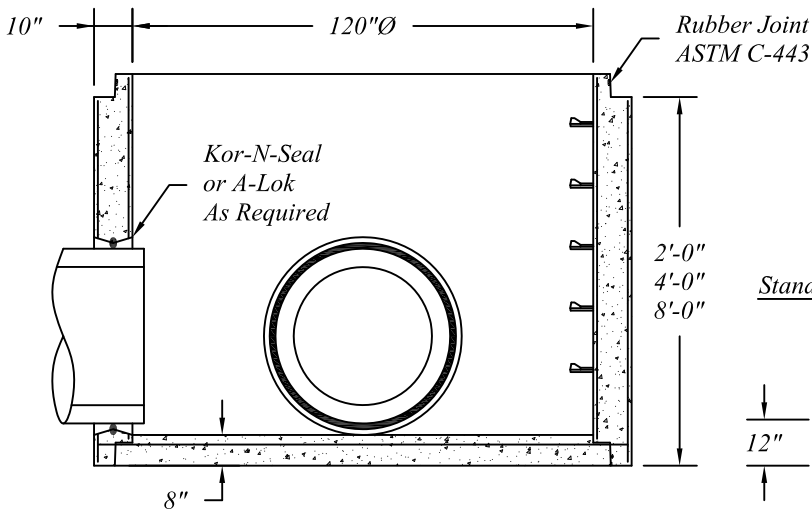

Standard Separate Bases

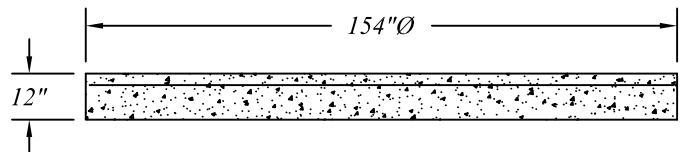

120" Manhole Pipe, Reducers, Covers and Bases Are Manufactured To ASTM C-478 Specifications.

Flat Covers Are Available With Optional Bolt Down Casting Assembly. See 48" Sanitary Manhole Detail.

Reinforcing Shown For Schematic Only.

Standard 120"Ø Precast Concrete Sanitary Manhole Sections



401 Kelton St Bay City, MI 48706

Date 12 May 16

5281 Lansing Rd  
Charlotte, MI 48813

2701 Chicago Dr SW  
Wyoming, MI 49519

Drawn By  
BmG

4950 White Lake Rd  
Clarkston, MI 48346

3756 Centennial Rd  
Sylvania, OH 43560

Scale  
NTS

02.23