

Standard 132" Storm Catch Basin Reducers

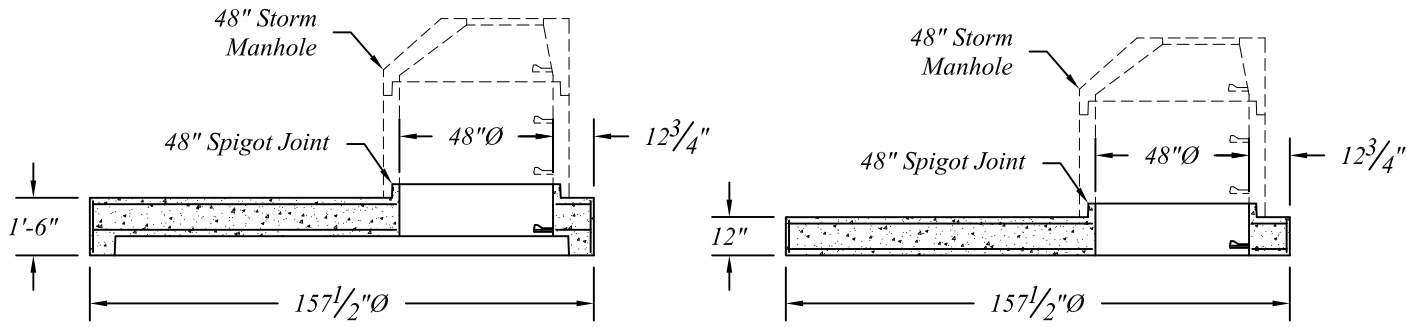

Standard 132" Storm Catch Basin Risers

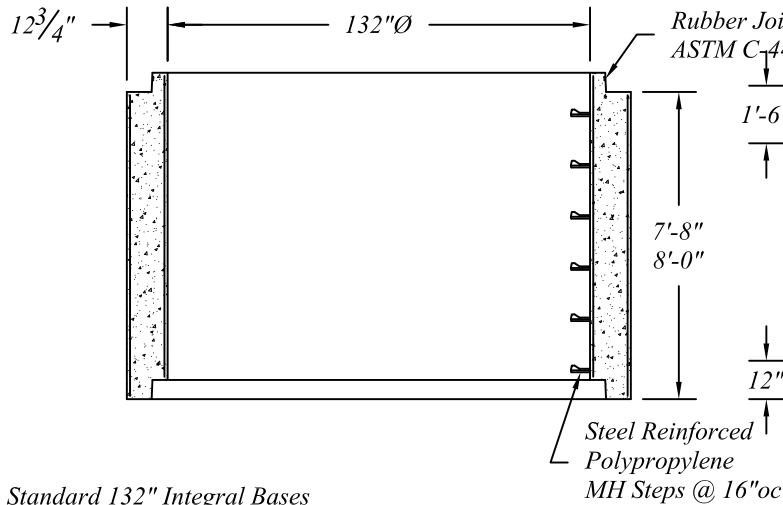

132" Storm Catch Basin Flat Covers
For Fill Less Than 3.5' Over Pipe

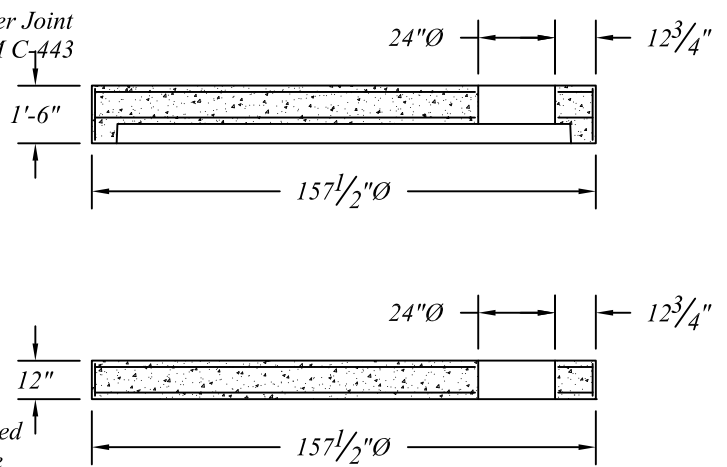

Standard 132" Integral Bases

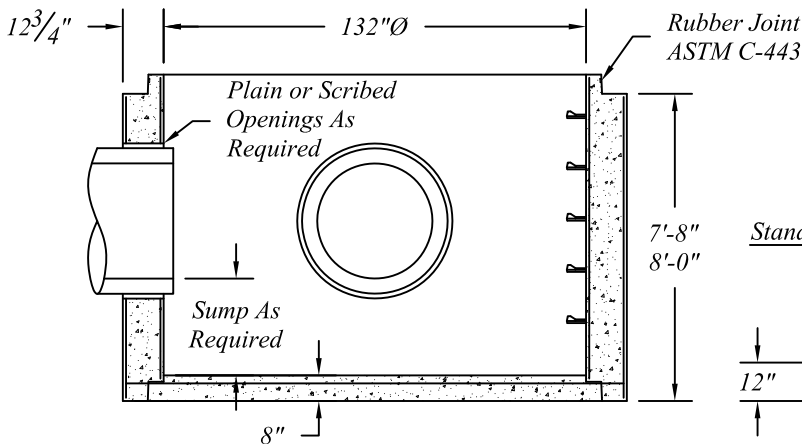

Standard Separate Bases

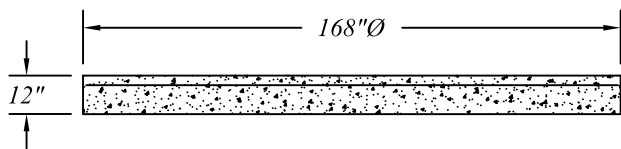

132" Catch Basin Pipe, Reducers, Covers and Bases Are Manufactured To ASTM C-478 Specifications.

Reinforcing Shown For Schematic Only.

Standard 132"Ø Precast Concrete Storm Catch Basin Sections



401 Kelton St Bay City, MI 48706

5281 Lansing Rd
Charlotte, MI 48813

2701 Chicago Dr SW
Wyoming, MI 49519

4950 White Lake Rd
Clarkston, MI 48346

3756 Centennial Rd
Sylvania, OH 43560

Date 01 Mar 21

Drawn By BmG

Scale NTS

02.25