

Standard 60" Storm Manhole Reducer

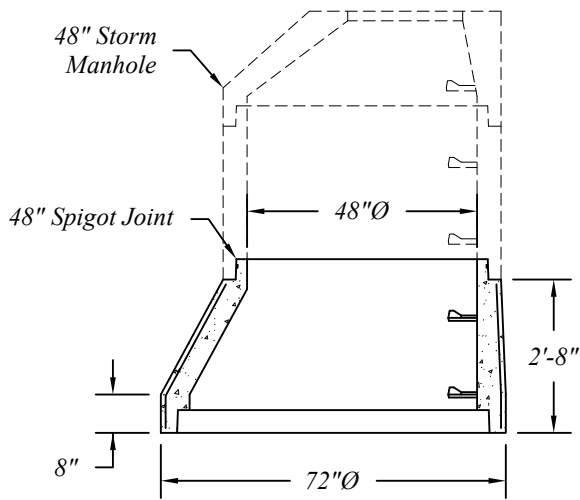

60" Storm Manhole Flat Reducers

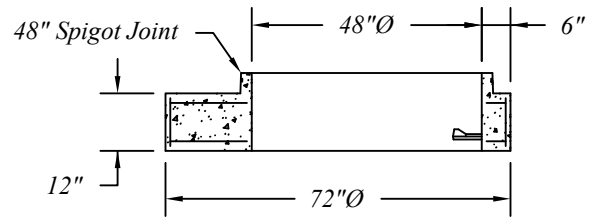
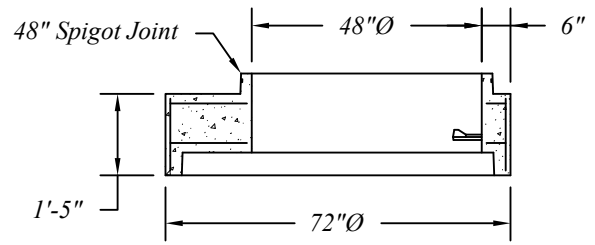

Standard 60" Storm Manhole Risers

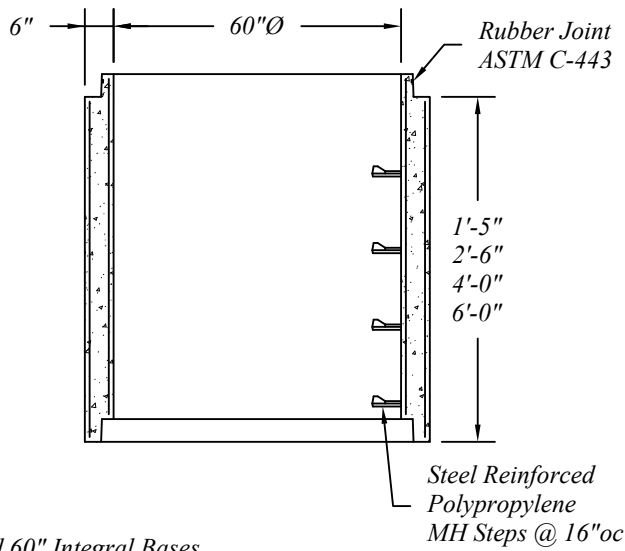

60" Storm Manhole Flat Covers
For Fill Less Than 3.5' Over Pipe

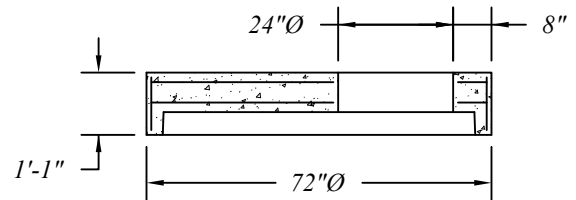
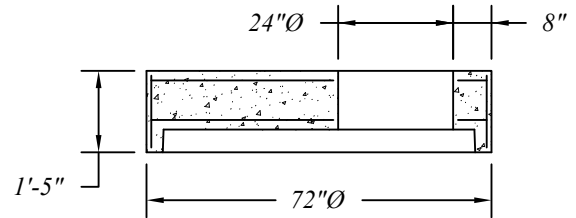

Standard 60" Integral Bases

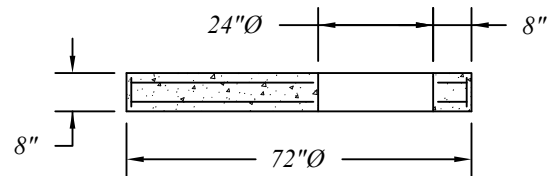
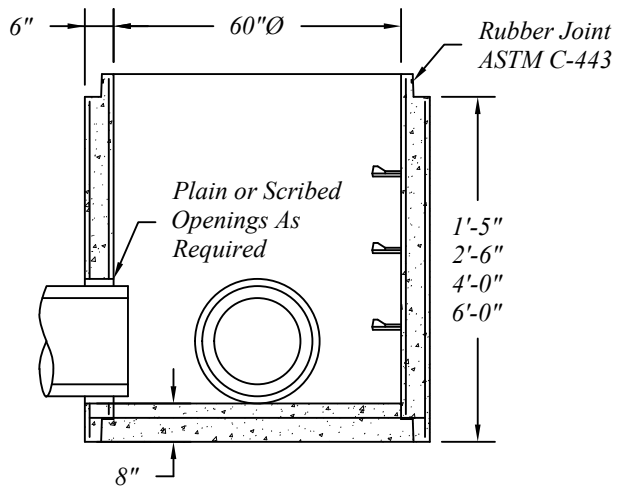

Standard Separate Bases

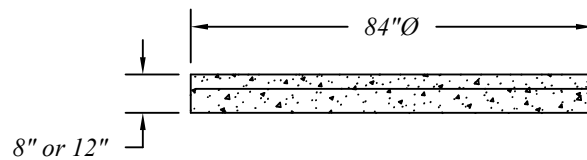

60" Manhole Pipe, Reducers, Covers and Bases Are Manufactured To ASTM C-478 Specifications.

Reinforcing Shown For Schematic Only.

Standard 60"Ø Precast Concrete Storm Manhole Sections



401 Kelton St Bay City, MI 48706
 5281 Lansing Rd Charlotte, MI 48813
 4950 White Lake Rd Clarkston, MI 48346
 2701 Chicago Dr SW Wyoming, MI 49519
 3756 Centennial Rd Sylvania, OH 43560

Date 12 May 16
 Drawn By BmG
 Scale NTS
02.06