

Standard 84" Sanitary Manhole Reducers

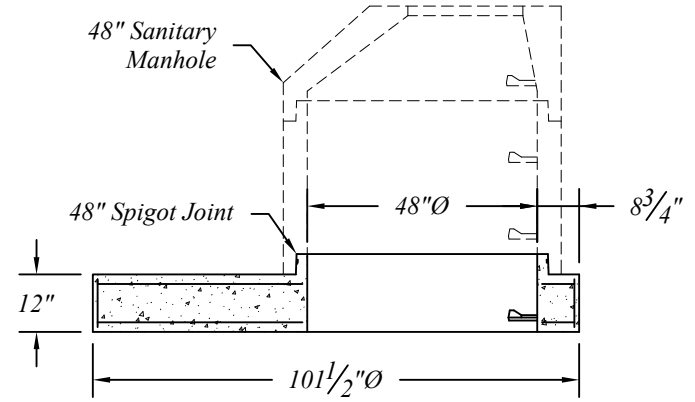

Standard 84" Sanitary Manhole Risers

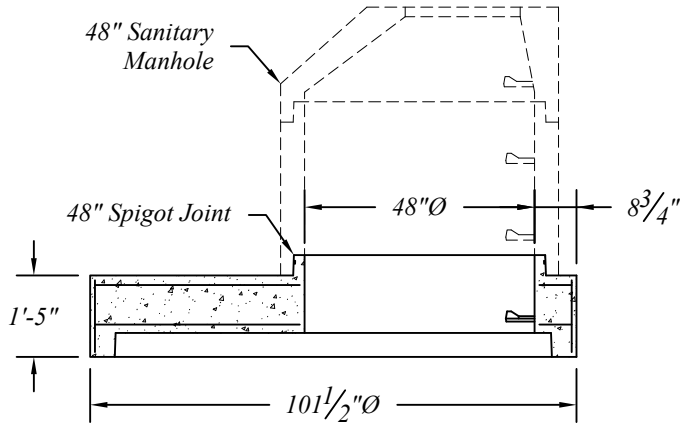
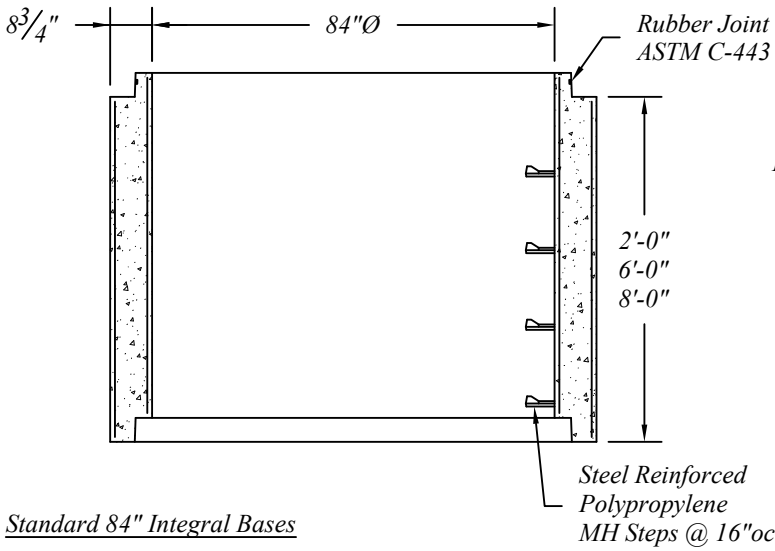

84" Sanitary Manhole Flat Covers
For Fill Less Than 3.5' Over Pipe

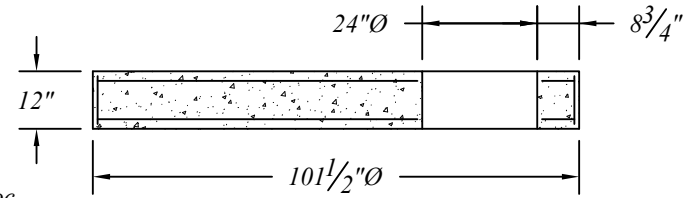
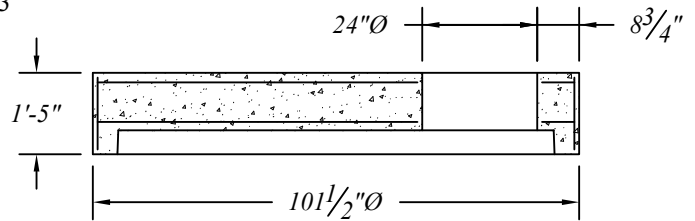

Standard 84" Integral Bases

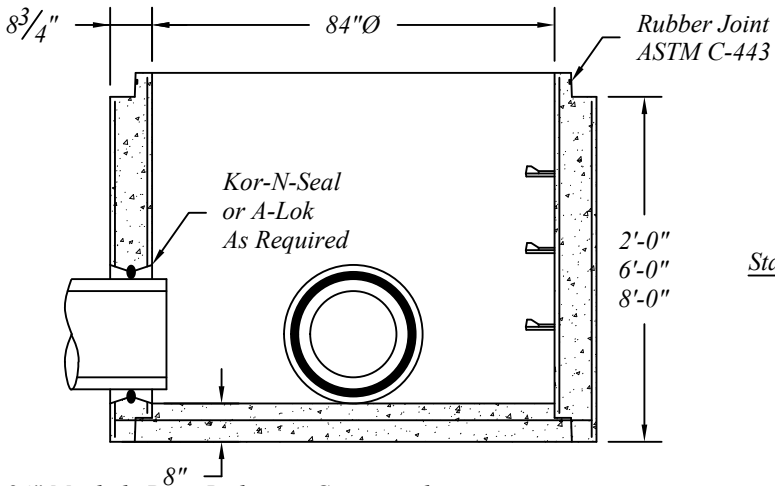

Standard Separate Bases

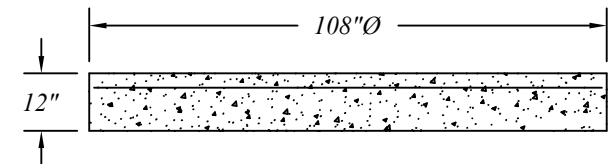

84" Manhole Pipe, Reducers, Covers and Bases Are Manufactured To ASTM C-478 Specifications.

Flat Covers Are Available With Optional Bolt Down Casting Assembly. See 48" Sanitary Manhole Detail.

Reinforcing Shown For Schematic Only.

Standard 84"Ø Precast Concrete Sanitary Manhole Sections			
	401 Kelton St Bay City, MI 48706		Date 12 May 16
	5281 Lansing Rd Charlotte, MI 48813	2701 Chicago Dr SW Wyoming, MI 49519	Drawn By BmG
	4950 White Lake Rd Clarkston, MI 48346	3756 Centennial Rd Sylvania, OH 43560	Scale NTS
			02.14