

Standard 96" Storm Manhole Reducers

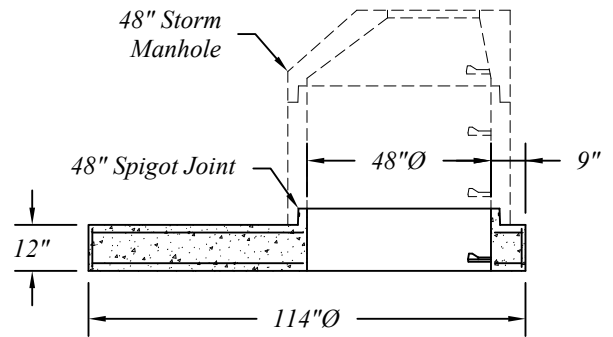

Standard 96" Storm Manhole Risers

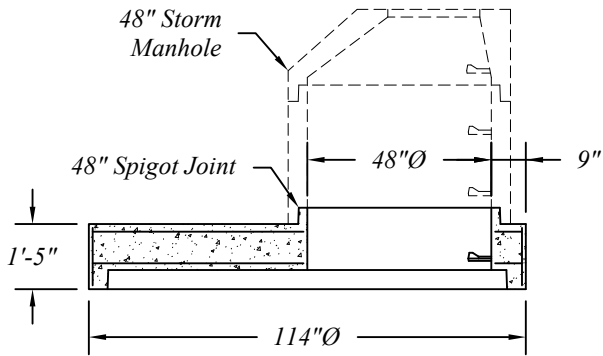
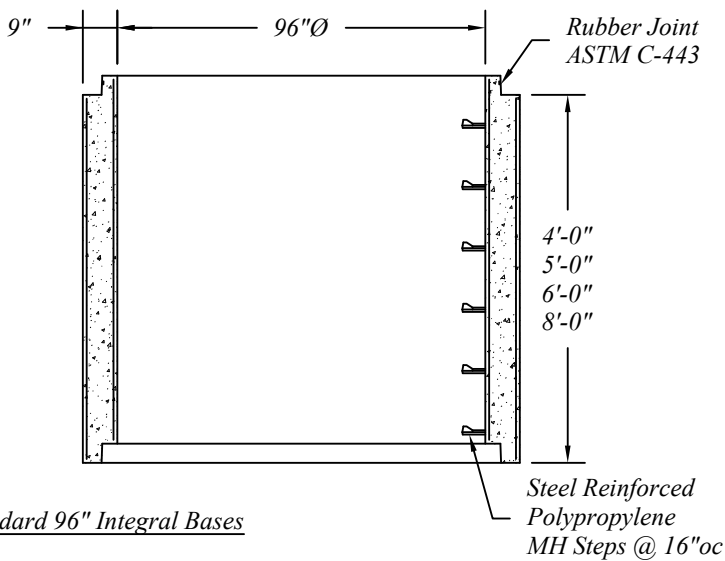

96" Storm Manhole Flat Covers
For Fill Less Than 3.5' Over Pipe

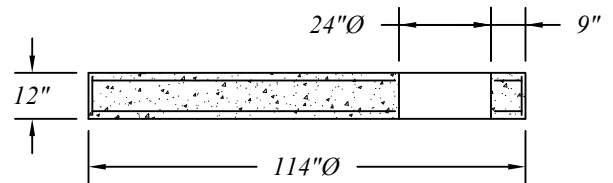
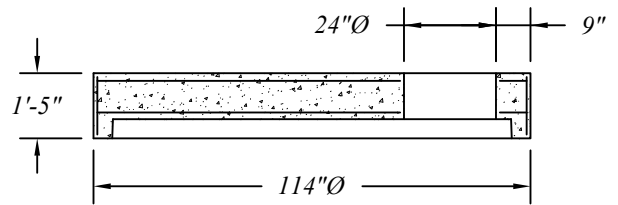

Standard 96" Integral Bases

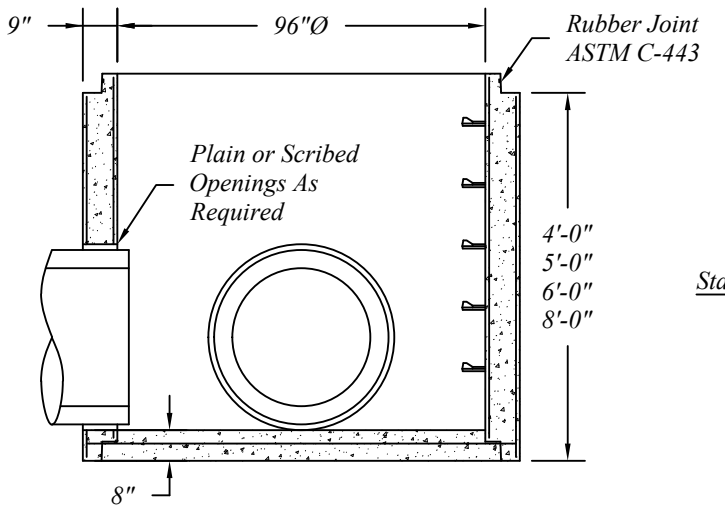

Standard Separate Bases

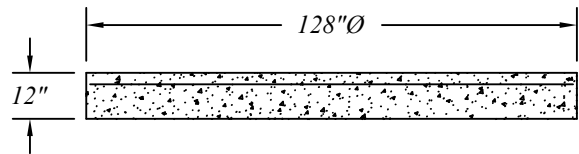

96" Manhole Pipe, Reducers, Covers and Bases Are Manufactured To ASTM C-478 Specifications.

Reinforcing Shown For Schematic Only.

Standard 96"Ø Precast Concrete Storm Manhole Sections			
	401 Kelton St Bay City, MI 48706		Date 12 May 16
	5281 Lansing Rd Charlotte, MI 48813	2701 Chicago Dr SW Wyoming, MI 49519	Drawn By BmG
	4950 White Lake Rd Clarkston, MI 48346	3756 Centennial Rd Sylvania, OH 43560	Scale NTS
			02.15